

# MD150T Manual

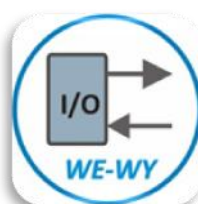

**Digital processing unit with display for  
force sensors without amplifiers**



[www.wobit.com.pl](http://www.wobit.com.pl)

P.P.H. WObit E.J.K. s.c.

Dęboczyce 16, 62-045 Pniewy

tel.48 61 22 27 422, fax.48 61 22 27 439

e-mail: [wobit@wobit.com.pl](mailto:wobit@wobit.com.pl) [www.wobit.com.pl](http://www.wobit.com.pl)

## Contains

|       |  |    |
|-------|--|----|
| 1.    | Safety and assembly rules.....                 | 3  |
| 2.    | Device description .....                       | 4  |
| 2.1   | Intended use and properties .....              | 4  |
| 2.2   | Description of connectors and front panel..... | 5  |
| 2.3   | Force sensor connection .....                  | 5  |
| 3.    | Menu description .....                         | 7  |
| 3.1   | MENU map .....                                 | 7  |
| 3.2   | Example of parameter change .....              | 8  |
| 4.    | Configuration of measurements.....             | 8  |
| 4.1   | Configuration of force sensor .....            | 8  |
| 4.2   | Reset of sensor indications .....              | 8  |
| 4.3   | Filtering of measurements .....                | 9  |
| 4.4   | Units of measurement .....                     | 9  |
| 5.    | Configuration of relay outputs .....           | 9  |
| 6.    | Password protection .....                      | 10 |
| 8.    | USB and RS485 MODBUS interfaces.....           | 11 |
| 8.1   | USB interface.....                             | 11 |
| 8.2   | RS485 (MODBUS-RTU) interface .....             | 11 |
| 8.2.1 | Description of MODBUS protocol .....           | 11 |
| 9.    | Complementary information .....                | 13 |
| 9.1   | Type of force sensors .....                    | 13 |
| 9.2   | Measuring range of sensor.....                 | 13 |
| 10.   | Technical parameters .....                     | 14 |

Thank you for selecting our product!

This instruction will help you at correct service and accurate exploitation of described device.

Information included in this instruction were prepared with high attention by our specialists and is description of the product without any responsibilities within the meaning of the commercial law. Based on the information should not be inferred a certain features or suitability for a particular application. This information does not release the user from the obligation of own judgment and verification. P.P.H. WObit E.K.J. Ober s.c. reserves the right to make changes without prior notice.

- Please read instructions below carefully and adhere to its recommendation
- Please pay special attention to the following characters:



**CAUTION!**

Not adhere to instruction can cause damage or impede the use of hardware or software.

# 1. Safety and assembly rules

## Safety rules

- Prior to first start-up of the device carefully read the manual.
- Prior to first start-up of the device make sure all cables are properly connected.
- Provide appropriate working conditions, in compliance with the device specifications (e.g.: power supply voltage, temperature, maximum current consumption).
- Prior to any modifications of cables connections, disconnect power supply voltage.
- Dismantling of the indicator housing during guarantee agreement period results in its invalidation.

## Assembly recommendation

In the environments of unknown levels of interruptions it is recommended to use the following means preventing against possible interruptions of the device operation:

- Ground or zero the metal rails on which instruments are mounted.
- Do not power the device from the same lines as high power devices without appropriate network filters.
- Apply power supply, sensor and signal cables screening while screen grounding should be connected only on one side as close to the device as possible.
- Use communication cables (USB) equipped with filters in the form of ferrite beads.
- Avoid routing control (signal) cables in parallel with or in close vicinity of power and supply cables.
- Avoid close vicinity of devices generating high level of electromagnetic and/or pulse interference (high power loads, loads with phase or group power regulation).

## 2. Device description

### 2.1 Intended use and properties

**MD150T** is an universal processing display indented to measurement signals from load cell force sensors. Built-in analog-digital transducer allows for measurement with resolution up to 100.000 of measuring range. The measurement result is presented on six position display.

MD150T has multipurpose usage as well at industry as in laboratory, where averaged or precise force (weight) measurement is necessary. Depends on used sensor there is a possibility of small masses in range as well small weights (grams) as large loads (tons).

MD150T has **2 relay outputs**, and 2 dedicated **inputs** (one tare input). Built-in operating modes enable the device to be used for dosing without any need for additionally controllers.

MD150T is also equipped with **USB** and **RS485 MODBUS** interfaces. USB interface allows fast configuration and recording measurement data in PC (e.g. to Excel file) with the use of MD150-PC software. MODBUS-RTU allows for reading of measurements from several indicators at the same time to PLC controller, HMI panel or its own PC application.

One-level menu of the device is easy in use, and to configure the device for specified sensor is needed only setting two parameters: *constant bridge sensitivity* (mV/V) and *bridge range* (N). User can also select units of displayed result.

MD150T has full aluminium profile housing compliant with DIN43700 standard which guarantees high mechanical durability and resistance to adverse environmental conditions including electric interference.





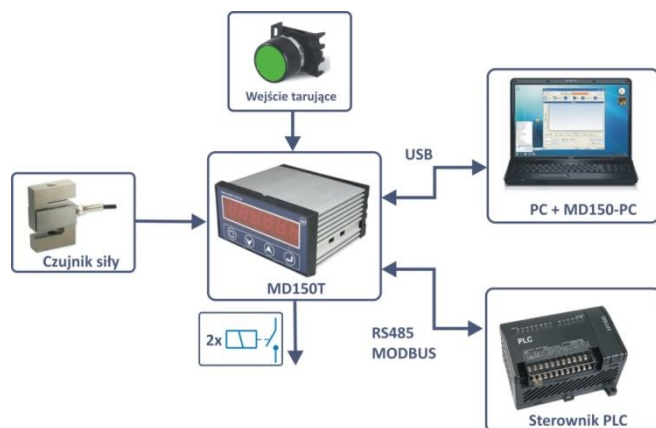

#### MD150T features:

- Result conversion to N, kN, g, kg, T, Funt,
- Digital filtering and average of measurements,
- Changes of status of relay outputs based on set thresholds.
- Memory of minimal and maximal value,
- External tare input,
- Cooperation with MD150T-PC software (communication by USB) for configuration and visualization of measurements,
- RS485 MODBUS-RTU interface,
- Solid, aluminum housing.



Picture. 1 Example of MD150T external connections.

## 2.2 Description of connectors and front panel

| Front panel   |  |
|---|--|
|  | LED1 - indicator of PK1 relay activation           |
|  | LED2 - indicator of PK2 relay activation           |
|  | ESC - abortion, Reset                              |
|  | DOWN - next menu position/next parameter digit     |
|  | UP - previous menu position / digit value increase |
|  | ENTER - menu entry/confirmation of entered changes |

| Back panel |      |                                     |
|------------|------|-------------------------------------|
| 1          | E+   | Power supply+ sensor (Excitatnion+) |
| 2          | S+   | Signal+ sensor (Signal+)            |
| 3          | S-   | Signal- sensor(Signal-)             |
| 4          | E-   | Power supply- sensor (Excitatnion-) |
| 5          | TARA | Tare input (+5..+24V)               |
| 6          | DIN2 | Universal input                     |
| 7          | 485A | A Signal of RS485 interface         |
| 8          | 485B | B Signal of RS485 interface         |
| 9,10       | PK1  | PK1 (NO) relay contacts             |
| 11,12      | PK2  | PK2 (NO) relay contacts             |
| 13         | V+   | 12-36 VDC power supply, min. 250mA  |
| 14         | GND  | Power supply mass                   |

## 2.3 Force sensor connection

MD150T digital processing unit can be integrated with any force sensor, which has input with resistance of standard bridge bigger than 150Ω. Sensor should be connect according to scheme below.

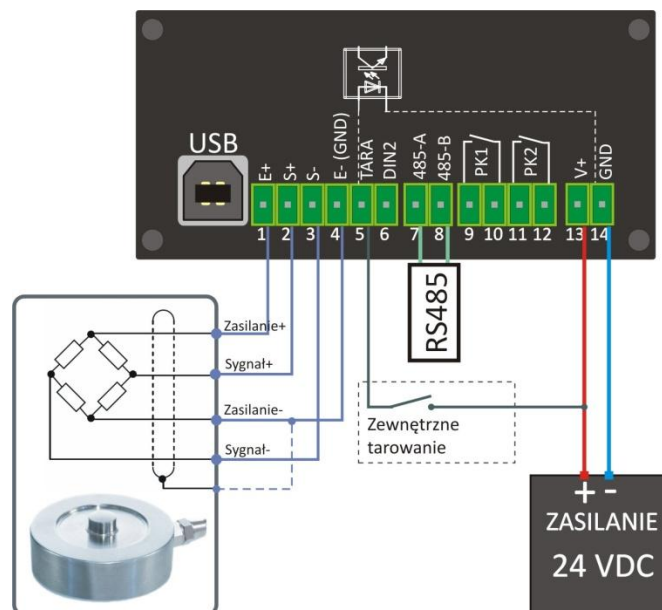

Picture. 2 Way of connecting force sensor to MD150T digital processing unit

| Sensor model          | K200, K300, K500,<br>KB52, KB82, KMB19,<br>KMB25, KMB31 | K701, K801,<br>K1101, K1506 | K1401, K1501,<br>K1600 | KMM20, KMM30, KMM40,<br>KMM50, KMM60, K1505,<br>EMS70, EMS150, EMS200 |
|-----------------------|---|-----------------------------|------------------------|---|
| Power supply+<br>(E+) | Red   | Brown                       | Red                    | White   |
| Power supply-<br>(E-) | Black   | Yellow                      | Black                  | Brown   |
| Signal+ (S+)          | Green   | Green                       | Brown                  | Yellow  |
| Signal- (S-)          | White   | White                       | Yellow                 | Green   |

Tab. 1 Description of cable colors for force sensors of WObit's offer.



**CAUTION!**

In longer period of time can happen, that derivation colors can change. Wrong connection do not cause damage device or sensor. It only cause indicating of opposite value (at changing E+ form E- or S+ from S- derivation), or incorrect (exchange between power supply and output).



















**CAUTION!**

Do not short-circuit derivation cables of sensor power supply (E+,E-), and also do not short-circuit E+ output to other derivation, it can cause damage of the device.

# 3. Menu description

## 3.1 MENU map















| 000000 -> displaying of current measurement value  |  |   |  |
|--|--|---|--|
| <br>Menu entry<br>           |  - Min. measurement value display<br><br> - Max. measurement value display | <br>(3 sec.) Zeroing of min/max measurement value  |  |
| 1. P1 -> Menu  |  |   |  |
|  <br>Next/previous parameter |  |   <br>parameter selection  |  Digit selection<br> Change value<br>Parameter edition |
| 1.   | P1   | PK1 relay threshold   | ± 999999   |
| 2.   | P2   | PK2 relay threshold   | ± 999999   |
| 3.   | P3-H   | Relays switching on/off hysteresis  | ± 999999   |
| 4.   | MODE   | Relays operational mode   | mode 0 / 1   |
| 5.   | TARA   | Zeroing of sensor indications   |  |
| 6.   | OFFS   | Offset for measuring value  | ± 999999   |
| 7.   | UNIT   | Units   | N, kN, g, kg, T, funt  |
| 8.   | RATE   | Measurement frequency   | 10 Hz / 80 Hz  |
| 9.   | FILT   | Level of averaging continuous filter  | 0...99   |
| 10.  | TRA  | <b>Bridge range</b> [N] configuration parameter   | 0..999999  |
| 11.  | TSE  | <b>Bridge constant</b> [mV/V] configuration parameter   | 0..99.9999   |
| 12.  | DP   | Number of decimals of the result  | 0..3   |
| 13.  | ADR  | MODBUS address  | 0-99   |
| 14.  | BAUD   | MODBUS baud rate  | 9600 / 19200 / 38400<br>57600 / 115200   |
| 15.  | BEP  | Keys audible signal   | On / OFF   |
| 16.  | LED  | Display brightness level  | 0-9  |
| 17.  | FAC  | Restoring factory default settings  |  |
| 18.  | PAS  | Password  | X-0000 - not active  |
| <br>Menu exit/abortion  |  |    <br>Parameter confirmation/abortion |  |



Blinking measurement value means exceeding of sensor rated load (more information- chapter Błąd! Nie można odnaleźć źródła odwołania.).

## 3.2 Example of parameter change

After correct connection of external elements and switching power supply on, MD150T process display is ready for operation with previously used settings, and in case of first operation – with factory settings.

- In order to enter programming mode, press . The display shows **1. PI**, if the password is switched off or **0000**, if it is active. In such case, in order to enter programming mode (at active password) enter the password and confirm it with the key ;
  - With subsequent pressing of  key you switch to next parameters and with pressing of  key you return to previous parameters.
  - At the selected parameter you want to change, press ;
  - With key  select display digit position you want to change and change its value with key . Confirm the entered value with key ;
  - Value of single digit parameters is selected with keys  and ;
  - If you want to enter a negative value select the first digit (from the left) then press and hold key  until the symbol “-” is displayed.
  - With key  you confirm the introduced change and with key  you abort the change or exit the menu.
- Prolonged pressing of keys  or  results in automatic increase/decrease of a given position/value.

## 4. Configuration of measurements

### 4.1 Configuration of force sensor

MD150T for correct displaying value from load cell requires giving of two parameters:

- **Parameter 10. TRA – bridge range.** Rated load of used sensor in N (1 – 999999), usually given on sensor casing,
- **Parameter 11. TSE – bridge constant** – sensitivity of used sensor in mV/V (0.0001 – 99), usually given on sensor casing or in its documentation.

Standard force sensors have constant with range 1 to 2mV/V with given accuracy by manufacturer (usually 0.05% - 0.5% linearity).

**KMMXX** sensor series from WObit's offer are characterized by specified constant for each model, given with accuracy up to 4 decimals. For example strain gauge bridge KMM20-500N type with given on causing 6724/06 serial number has 0.9906 constant (value read from bridge documentation).

For example for KMM20-500N sensor with 0,9906 constant MD150T should be configure, respectively:

- To **10. TRA** parameter set 500 value
- To **11. TSE** parameter set 0,9906 value

### 4.2 Reset of sensor indications

- Reset from keyboard: Menu -> 5. TARA -> Confirmation.





- Reset by external signal TARA (clamp nr. 5). Reset signal should has length min. 10ms, and interval between next reset signals should not be shorter than 0,5 sec.

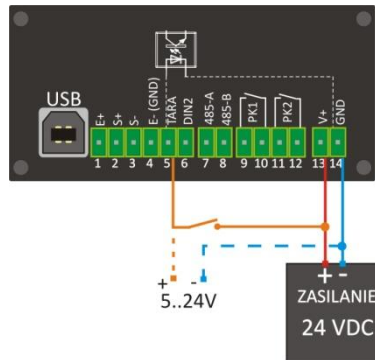

Picture. 3 Reset of sensor by external signal TARA.



Reset value is remain at non-volatile memory of digital processing unit.

### 4.3 Filtering of measurements

Parameters **8. RATE** and **9.FILT** have influence on indications durability.

- Parametr **8. RATE** specifies measurement frequency(10Hz, 80 Hz). Lower frequency provides more stabile indications.
- Parametr **9. FILT** specifies filtration level of digital averaging filter. Higher filtration value (max. 99) provides more stabile indications, however, response to changes of the measured signal is slower.

### 4.4 Units of measurement

Units of measurement are set by **7. UNIT** parameter. The user has following units for selection:

- 1 **N** – Newton’s, 2 **kN** – kilonewtons, 2 **g** – grams, 3 **kg** – kilograms, 4 **T** – tones, 5 **Funt**-pound

Additionally **12. DP** parameter specifies number of decimal places of indicated value. When DP will set on 0 digital processing unit will display only complete part of measurement. For DP = 4 result will has four decimal places.

Parameter DP influence also on measurement range of set parameters. If **DP = 0**, then **P1, P2, P3-H settings**, could be change only at complete part in range -99999 do 999999. If **DP=4** parameters above could be change in range of -99.9999 up to 99.9999.

## 5. Configuration of relay outputs

MD150T digital processing unit has 2 relay outputs PK1 and PK2 which can be switched on/off depending on current measurement value. The following parameters are used for relay outputs configuration:

1. **P1** - activation (deactivation) threshold of PK1 relay
2. **P2** - activation (deactivation) threshold of PK2 relay



3. **P3-H** - hysteresis level of activation/deactivation of PK1 and PK2 outputs

4. **MODE** - output operating mode:

- **Mode 0** – Absolute with two thresholds. Activation of PK1 and PK2 outputs is realized after reaching of P1 and P2 values, respectively.
- **Mode 1** – Reverse with two thresholds. Operation is similar to the above mode. Deactivation

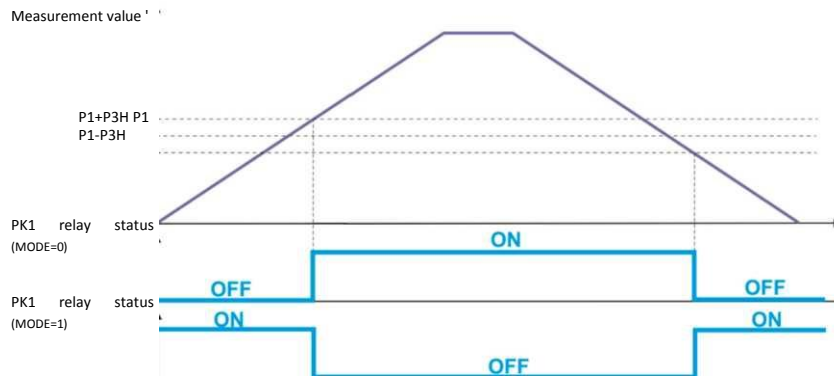

Fig. 2 Example of PK1 relay output activation depending on P1 and P3H setting and operating mode (MODE).  
of PK1 and PK2 outputs is realized after reaching of P1 and P2 values, respectively.

## 6. Password protection

Access to the process display settings can be password protected (parameter 11. PAS). There are 3 protection levels available. Protection level is set with the first digit, and the last 4 digits are used for password entry.

|        |  |
|--------|--|
| 0-0000 |  |
|        | 4-digit password (0-9999)                            |
|        | Protection level:                                    |
|        | 0-Settings protection above <b>12. DP</b> parameter  |
|        | 1-Settings protection above <b>3. P3-H</b> parameter |
|        | 2-Protection of all settings                         |

If the digital processing unit is password protected, then after switching to protected settings the display shows 0000 value – enter previously set password. The password can be deactivated by switching the parameter 18.PAS and setting 0000 value.

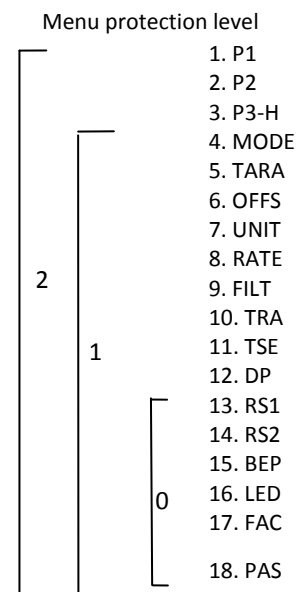

# 7. USB and RS485 MODBUS interfaces

## 7.1 USB interface

USB interface is used for communication of MD150T process display with MD150-PC software (device configuration, recording of measurements) and for updating of internal software. MD150 process display must be powered in order to facilitate communication via USB.



### Caution!

USB interface is prone to interference in the power supply grid and to electromagnetic interference occurring in industrial environments. In case of connection problems during communication of the digital processing unit with MD150T-PC software, apply additional protective elements in the form of:

- Powering of MD150T digital processing unit from an independent power supply source,
- Application of network filters upstream of the indicator supply feeder.
- Use of USB cable of length <1,5m equipped with ferrite beads at the cable beginning and its end.
- Use of optically insulated USB hubs at PC side.

In the conditions of severe interference (e.g. high interference of power grid) the communication may not be possible.

## 7.2 RS485 (MODBUS-RTU) interface

MD150T digital processing unit is equipped with RS485 interface. It can be used for communication with PLC controller, HMI panel or other device supporting MODBUS-RTU protocol. Default transmission parameters:

- Speed: **38400bps**, Bits: 8, Stop Bits: 1, parity: none
- Address **Modbus: 1**

Transmission speed and MD150T digital processing unit address in MODBUS-RTU network can be set with the following parameters:

**13. ADR** - speed setting MODBUS (9600, 19200, 38400, 57600, 115200)

**14. BAUD** - address setting MODBUS (1...99)

### 7.2.1 Description of MODBUS protocol

#### Implemented functions MODBUS

| Function no(hex) | Description                        |
|------------------|------------------------------------|
| 1 (0x01)         | Reading of outputs status (relays) |
| 3 (0x03)         | Reading X registers                |
| 5 (0x05)         | Recording of single Bit            |

#### Type of variables used

| Name | Description                 | Size (Bytes) | Number of occupied registers |
|------|-----------------------------|--------------|------------------------------|
| DINT | Complete number with a sign | 4            | 2                            |
| REAL | Floating point number       | 4            | 2                            |

## Map of MD150T records

| Address         | Name         | Variable type | Mode(Modbus function) | Description  |
|-----------------|--------------|---------------|-----------------------|--|
| 0 -1 (*1-2)     | MES_DINT     | DINT          | R (0x03)              | Measurement value (only complete part)                 |
| 2 -3 (*3-4)     | MES_MIN_DINT | DINT          | R (0x03)              | Registered minimal value (only complete part)          |
| 4 -5 (*5-6)     | MES_MAX_DINT | DINT          | R (0x03)              | Registered maximal value (only complete part)          |
| 6 -7 (*7-8)     | MES_REAL     | REAL          | R (0x03)              | Measurement value (floating point)                     |
| 8 -9 (*9-10)    | MES_MIN_REAL | REAL          | R (0x03)              | Registered minimal value (floating point)              |
| 10 -11 (*11-12) | MES_MAX_REAL | REAL          | R (0x03)              | Registered maximal value (floating point)              |
| 5000 (*5001)    | TARA         | BYTE          | W (0x05)              | Reset of sensor indications.                           |
| 5002 (*5003)    | PK_OUT       | BYTE          | R (0x01)              | Reading of relay outputs status (bit 0:PK1, bit 1:PK2) |
| 4000 (*4001)    | INPUTS       | BYTE          | R (0x01)              | Reading of inputs status (bit 0: TARA. bit 1: DIN2)    |

\* for devices with address starting with 1 value(offset address +1)

R – reading register, W - record

CAUTION: 4-Byte number of type REAL is contained in two registries. The first registry contains younger part of the number, the second - its older part. In order to read REAL number value correctly, read registries of number 2 and 3 and then conduct appropriate conversion.

Conversion of 2 registries (4 Byte) into 32 Bit number REAL

Registry\_2 HI <-> Byte1

Registry\_2 LO <-> Byte0

Registry\_3 HI <-> Byte3

Registry\_3 LO <-> Byte2

Number\_32\_bit = Byte3<<24 + Byte2<<16 + Byte1<<8 + Byte0

Or number\_32\_bit = Registry\_2 + Registry\_3<<16

For DINT registers, if measurement result is within range -32768 up to 32767 reading of first register is enough.

## Example of MODBUS communication table

Reading of measurement (DINT value) – MES\_DINT (Function: 03, Registry address: 0)

| Request (MODBUS MASTER -> MD150T) |      | Response (MD150T -> MODBUS MASTER) |               |
|-----------------------------------|------|------------------------------------|---------------|
| Device address                    | 0x01 | Device address                     | 0x01          |
| Function                          | 0x03 | Function                           | 0x03          |
| Hi registry address               | 0x00 | Byte number                        | 0x04          |
| Lo registry address               | 0x00 | Registry 0x02 Hi                   | REAL (Byte1)  |
| Number of Hi registries           | 0x00 | Registry 0x02 Lo                   | REAL (Byte 0) |
| Number of Lo registries           | 0x02 | Registry 0x03 Hi                   | REAL (Byte 3) |
| CRC Hi                            | 0xC4 | Registry 0x03 Lo                   | REAL (Byte 2) |
| CRC Lo                            | 0x0B | CRC Hi                             | 8 bit         |
|                                   |      | CRC Lo                             | 8 bit         |

Reset of digital processing unit - TARA (Function: 05, Registry address: 5000)





| Request (MODBUS MASTER -> MD150T) |          | Response (MD150T -> MODBUS MASTER) |          |
|-----------------------------------|----------|------------------------------------|----------|
| Device address                    | 0x01     | Device address                     | 0x01     |
| Function                          | 0x05     | Function                           | 0x05     |
| Address of Hi registries          | 0x13     | Address of Hi registries           | 0x13     |
| Address of Lo registries          | 0x88     | Address of Lo registries           | 0x88     |
| Registry 0x00 Hi                  | 0xFF     | Registry 0x00 Hi                   | 0xFF     |
| Registry 0x00 Lo                  | 0x00     | Registry 0x00 Lo                   | 0x00     |
| CRC                               | 16 Bytes | CRC                                | 16 Bytes |



## 8. Complementary information

### 8.1 Type of force sensors

WObit company has a broad offer of force sensors in range from single Newton's up to hundreds of kilonewtons. Depends on assembly and way of measuring force (tension, compression) are available sensors with different shapes (table below).

|  |   |
|--|---|
| <p>Beam</p>               | To measure tension force. Range of measured force 0..350N.<br>Example of models: K200, K300   |
| <p>S-beam</p>             | To measure large tension force. Range of measured force 0..75kN.<br>Example of models: K1401, K1501, K1505, K1506, K1600                                |
| <p>Round</p>              | To measure large and small tension force. Range of measured force 0..100kN.<br>Example of models: KB52, KB82, KMB19, KMB25, KMB31, KMM30, KMM50, KMM60, |
| <p>Round with shaft</p>  | To measure large and small tension and compression force. Range of measured force 0..50kN.<br>Example of models: KMM20, KMM40                           |
| <p>Cylindrical</p>      | To measure large tension and compression force. Range of measured force 0..200kN.<br>Example of models: K1101   |

### 8.2 Measuring range of sensor

|                 |           |                 |
|-----------------|-----------|-----------------|
| Destroying load | >200% TRA |                 |
| Cut-off load    | +200% TRA |                 |
| Applied load    | +150% TRA |                 |
| Rated load      | +100% TRA | Measuring range |
| Zero load       | 0 [N]     |                 |
| Rated load      | -100% TRA |                 |

**Rated load** for sensor it is a size of force, which specifies top value of measuring range (given value for sensor as **bridge range -TRA** in N).

|                 |           |
|-----------------|-----------|
| Applied load    | -150% TRA |
| Cut-off load    | -200% TRA |
| Destroying load | <200% TRA |

**Applied load** is the biggest force, which have unambiguous connection between force and output signal (signal value is changing linear in relation to force). It can count max. **M150%** of sensor range (bridge).

**Cut-off load** is the biggest force, which can Take each sensor without it damage. It can count max. **200%** of sensor range.

**Destroying load** means force applied to sensor Shaft, which exceeding can cause to mechanical damage of the sensor.

Constant of e.g. KMM60 sensor is  $1,5\text{mV/V} \pm 2\%$ . Error of the sensor is specified by following values: tolerance of linearity 0,2% of measuring range, zero tolerance 2% of measuring range, hysteresis 0,2% of range and creep measured in time of 30 minutes 0,1%. Temperature factor of zero point and constant is 0,1% of range/ $10^{\circ}\text{C}$ . Bridge resistance on input has  $380\text{om} \pm 10\%$  and output resistance has  $350\text{om} \pm 5\%$ .

## 9. Technical parameters

| Description                 | Parameter   |
|-----------------------------|---|
| Power supply                | 12 ... 36 VDC, 250mA  |
| Sensor input                | Sensor power supply: 5V<br>Max. differential voltage: $\pm 39\text{mV}$ ,<br>Resolution: 0,001% FS,<br>Temperature error: 0,0025%/C°<br>Frequency of measurements: 10Hz, 80Hz |
| Zeroing input TARA          | Low level: 0V (max. 2V), high level: +24V (5...24V)<br>Minimal pulse length >10ms, minimal pause. 0,5sek.   |
| Relay outputs PK1, PK2      | 2 x 1A/125VAC, 2A/30VDC   |
| Interfaces                  | RS485 MODBUS-RTU, default parameters 38400bps, 8:n:1,<br>USB: 1.1, 2.0  |
| Operating temperature range | 0..50° C  |
| Display                     | 6 digits, height 13.5 mm  |
| Housing                     | height: 45 mm<br>width: 92 mm<br>length: 81 mm  |
| Weight                      | 200g  |
| Degree of protection        | IP40, from panel head – IP65  |
| Universal password          | 3145  |